



**clearly  
the best**

Product Catalogue  
Winter 2017

## Brochure Holders International

We are delighted to present the new catalogue which has been designed as a reference tool for the items in our Taymar range.

Detailed product information can also be found on our website [www.brochureholders.com](http://www.brochureholders.com). Pricing is available separately.

Brochure Holders International Limited is part of the global Taymar group recognised as a world leading manufacturer of premium quality injection moulded leaflet holders/brochure display units. The corporation has built an industry wide reputation for deliverable quality with its 'Taymar' brand which is founded on three fundamental commercial tenets: Service, quality and competitive pricing.

Trading began in the early Eighties and the group has been a driving force in helping world commerce better present its products and services at the point of sale and purchase. We offer one of the worlds largest ranges of 'crystal clear' wall, floor and counter standing brochure display options. Our aim is to provide European businesses with a classic point of sale solution to help them sell more.

## Corporate Strategy

The entire range of recyclable Taymar products is manufactured to the highest quality control standards. We aim to add new products to our range each year and continue to invest heavily in research and development. Latest state of the art, robot-driven, multi-cavity injection moulding machines enables the company to maintain both quality control targets and a keenly competitive pricing strategy.

Our sales are primarily channelled through an extensive range of wholesalers and distributors.

Comprehensive stock availability is key to our corporate strategy and our location, which is close to ports, airports and major road links, allows us to fulfil a market-leading 99% of all orders within 24 - 48 hours.

Our success has been underscored with first class support for our key distributor network. With the help of our expert in-house team we can provide our customers with rapid order fulfilment across every European territory.

## Contact & Advice

We have considerable combined experience in the world of brochure holders and the injection moulding process. If you are interested in representing or stocking our products or if you are an existing distributors wishing to increase product range offered our team of knowledgeable staff are on hand to assist with your requirements and technical queries.

Tel: +44 (0)1473 229250

Email: [sales@brochureholders.co.uk](mailto:sales@brochureholders.co.uk)

Fax: +44 (0)1473 229251

# Contents

1. Counter Stands - Taymar
2. Wall Mounting - Taymar
3. Wall Mounting - ClipLock
4. Business Card
5. Single Page
6. Outdoor Leaflet Holders
7. Floor Standing Carousels
8. Desktop Spinners - Taymar
9. Desktop Spinners - ClipLock
10. Floor Stands
11. Wall System - Taymar
12. Wall Systems - ClipLock
13. Accessories & Parts
14. Screen Printing



# 1. Counter Stands - Taymar

A comprehensive range of counter standing brochure holders designed to suit all popular paper sizes. Multi-tier and multi-pocket versions available.

Visit [www.brochureholders.com](http://www.brochureholders.com) for further details.

## 1/3<sup>rd</sup> A4 / DL

SIZE: 1/3<sup>rd</sup> A4/DL



**CL230**  
1 pocket 1/3rd A4/DL landscape leaflet holder  
Carton quantity 48  
Opening dimensions: **230 x 32mm**  
Crystal Clear Polystyrene

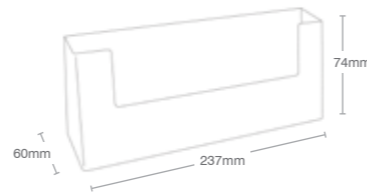

SIZE: 1/3<sup>rd</sup> A4/DL



**C110**  
1 pocket 1/3rd A4/DL portrait leaflet holder  
Carton quantity 80  
Opening dimensions: **110 x 32mm**  
Crystal Clear Polystyrene



SIZE: 1/3<sup>rd</sup> A4/DL



**FP110**  
1 pocket 1/3rd A4/DL flat pack leaflet holder  
Carton quantity 100  
Opening dimensions: **110 x 32mm**  
Polypropylene

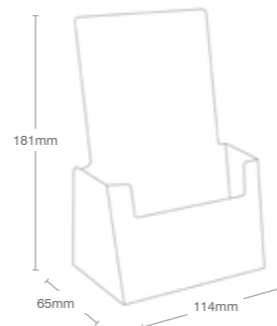

SIZE: 1/3<sup>rd</sup> A4/DL



**TS110**  
1 pocket 1/3rd A4/DL portrait leaflet holder  
Carton quantity 40  
Pocket is open-ended and can accommodate oversized 1/3rd A4/DL leaflets. Pocket depth: 32mm  
Crystal Clear Polystyrene

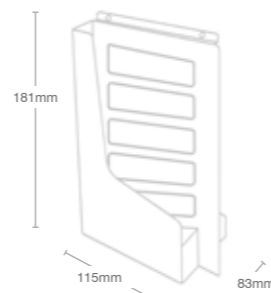

SIZE: 1/3<sup>rd</sup> A4/DL



**W110** - with removable AB1 counter stand clip  
1 pocket 1/3rd A4/DL portrait leaflet holder  
Carton quantity 100  
Opening dimensions: **110 x 32mm**  
Crystal Clear Polystyrene

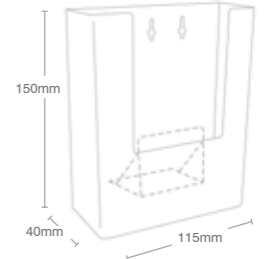

SIZE: 1/3<sup>rd</sup> A4/DL



**2C110**  
2 pocket 1/3rd A4/DL portrait leaflet holder  
Carton quantity 32  
Opening dimensions: **110 x 32mm**  
Crystal Clear Polystyrene

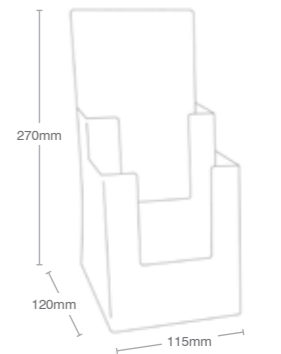

SIZE: 1/3<sup>rd</sup> A4/DL



**2C112**  
2 pocket 1/3rd A4/DL portrait leaflet holder  
Carton quantity 36  
Opening dimensions: **112 x 32mm**

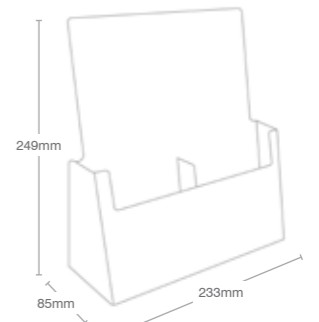

SIZE: 1/3<sup>rd</sup> A4



**3C104**  
3 pocket 1/3rd A4 portrait leaflet holder  
Carton quantity 20  
Opening dimensions: **104 x 32mm**  
Crystal Clear Polystyrene

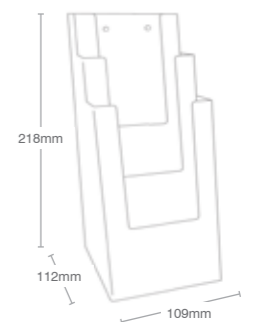

SIZE: 1/3<sup>rd</sup> A4/DL



**3C110H**  
3 pocket 1/3rd A4/DL portrait leaflet holder  
Carton quantity 24  
Opening dimensions: **110 x 32mm**  
Crystal Clear Polystyrene

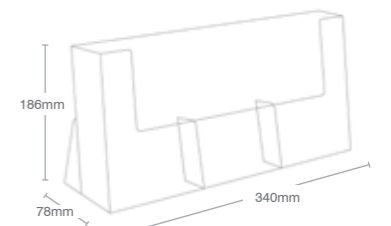

SIZE: 1/3rd A4



**4W104** - with removable AB1 counter stand clip  
**4 pocket 1/3rd A4 portrait leaflet holder**  
 Carton quantity 24  
 Opening dimensions: **104 x 32mm**  
 Crystal Clear Polystyrene

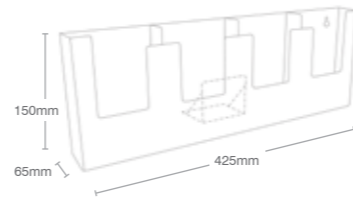

SIZE: 1/3rd A4/DL



**4C110**  
**4 pocket 1/3rd A4/DL portrait leaflet holder**  
 Carton quantity 20  
 Opening dimensions: **110 x 32mm**  
 Crystal Clear Polystyrene

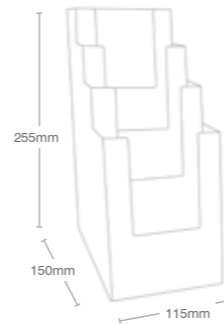

SIZE: 1/3rd A4/DL



**2C230** - supplied with 2 removable CD pocket dividers  
**4 pocket 1/3rd A4/DL portrait leaflet holder**  
 Carton quantity 16  
 Opening dimensions: **110 x 32mm**  
 Crystal Clear Polystyrene

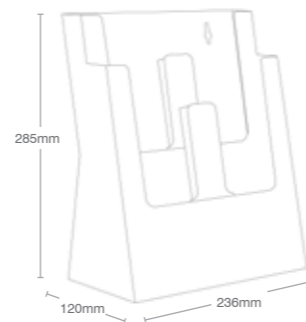

SIZE: 1/3rd A4/DL



**4C230** - supplied with 4 removable CD pocket dividers  
**8 pocket 1/3rd A4/DL portrait leaflet holder**  
 Carton quantity 8  
 Opening dimensions: **110 x 32mm**  
 Crystal Clear Polystyrene

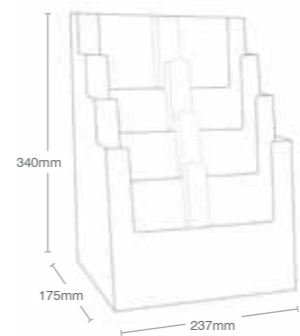

SIZE: 1/3rd A4/DL



**4C330** - supplied with 8 removable CD pocket dividers  
**12 pocket 1/3rd A4/DL portrait leaflet holder**  
 Carton quantity 8  
 Opening dimensions: **110 x 32mm**  
 Crystal Clear Polystyrene

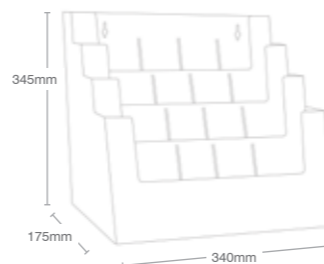

SIZE: A4



**C330**  
**1 pocket A4 landscape leaflet holder**  
 Carton quantity 24  
 Opening dimensions: **330 x 32mm**  
 Crystal Clear Polystyrene

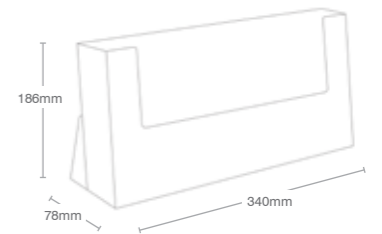

SIZE: A4



**C230**  
**1 pocket A4 portrait leaflet holder**  
 Carton quantity 36  
 Opening dimensions: **230 x 32mm**  
 Crystal Clear Polystyrene

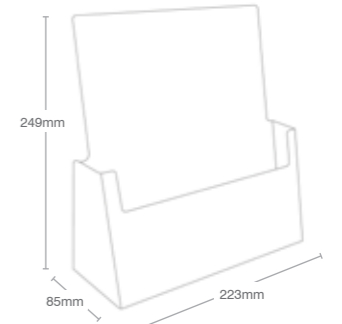

SIZE: A4



**TS230**  
**1 pocket A4 portrait leaflet holder**  
 Carton quantity 32  
 Pocket is open-ended and can accommodate oversized A4 leaflets. Pocket depth: 32mm  
 Crystal Clear Polystyrene

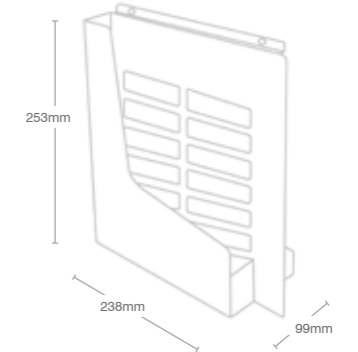

SIZE: A4



**W230** - with removable AB1 counter stand clip  
**1 pocket A4 portrait leaflet holder**  
 Carton quantity 44  
 Opening dimensions: **230 x 32mm**  
 Crystal Clear Polystyrene

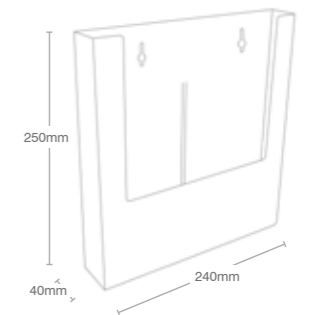

SIZE: A4



**2C230X**  
**2 pocket A4 portrait leaflet holder**  
 Carton quantity 16  
 Opening dimensions: **230 x 32mm**  
 Crystal Clear Polystyrene

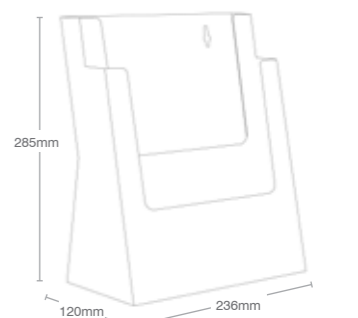

SIZE: A4



**2C230** - supplied with 2 removable CD pocket dividers  
**2 pocket A4 portrait leaflet holder**  
 Carton quantity 16  
 Opening dimensions: **230 x 32mm**  
 Crystal Clear Polystyrene

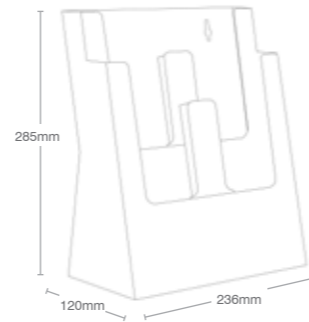

SIZE: A4



**4C330** - supplied with 8 removable CD pocket dividers  
**4 pocket A4 leaflet holder**  
 Carton quantity 8  
 Opening dimensions: **330 x 32mm**  
 Crystal Clear Polystyrene

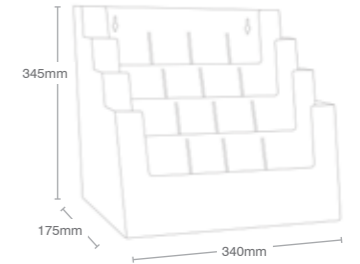

SIZE: A4



**3C230**  
**3 pocket A4 portrait leaflet holder**  
 Carton quantity 12  
 Opening dimensions: **230 x 32mm**  
 Crystal Clear Polystyrene

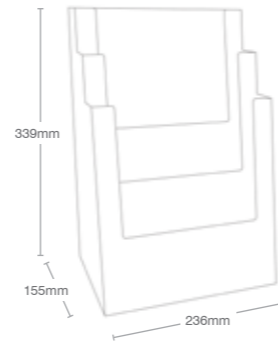

SIZE: A5

**A5**



**CLA5**  
**1 pocket A5 landscape leaflet holder**  
 Carton quantity 48  
 Opening dimensions: **230 x 32mm**  
 Crystal Clear Polystyrene

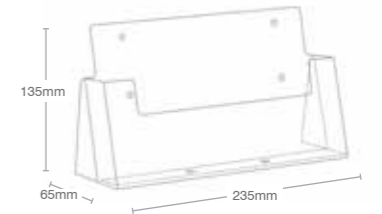

SIZE: A4



**4C230X**  
**4 pocket A4 portrait leaflet holder**  
 Carton quantity 8  
 Opening dimensions: **230 x 32mm**  
 Crystal Clear Polystyrene

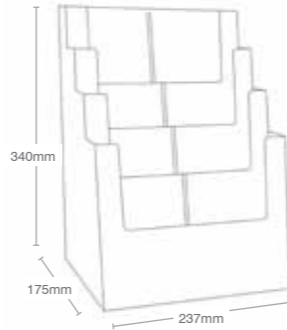

SIZE: A5



**C160**  
**1 pocket A5 portrait leaflet holder**  
 Carton quantity 80  
 Opening dimensions: **160 x 32mm**  
 Crystal Clear Polystyrene

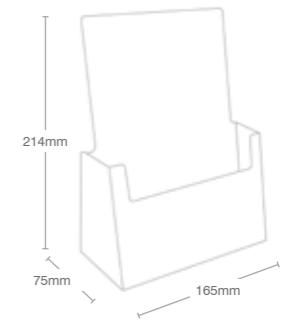

SIZE: A4



**4C230** - supplied with 4 removable CD pocket dividers  
**4 pocket A4 portrait leaflet holder**  
 Carton quantity 8  
 Opening dimensions: **230 x 32mm**  
 Crystal Clear Polystyrene

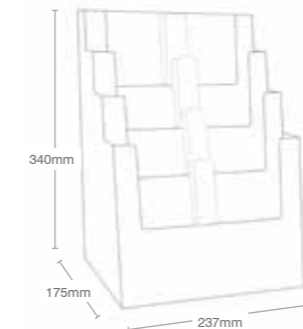

SIZE: A5



**W160** - with removable AB1 counter stand clip  
**1 pocket A5 portrait leaflet holder**  
 Carton quantity 88  
 Opening dimensions: **160 x 32mm**  
 Crystal Clear Polystyrene

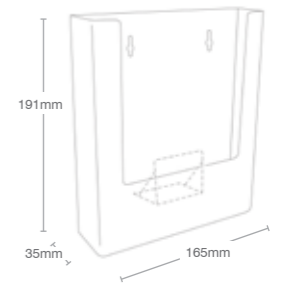

SIZE: A4



**4C330X**  
**4 pocket A4 landscape leaflet holder**  
 Carton quantity 8  
 Opening dimensions: **330 x 32mm**  
 Crystal Clear Polystyrene

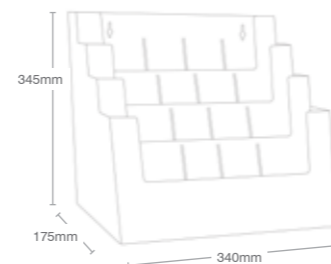

SIZE: A5



**2C155H**  
**2 pocket A5 portrait leaflet holder**  
 Carton quantity 24  
 Opening dimensions: **160 x 32mm**  
 Crystal Clear Polystyrene

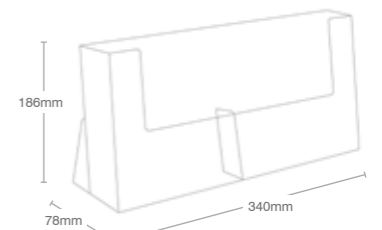

SIZE: A5



**2C160**  
**2 pocket A5 portrait leaflet holder**  
 Carton quantity 24  
 Opening dimensions: **160 x 48mm**  
 Crystal Clear Polystyrene



SIZE: A5



**3C160**  
**3 pocket A5 portrait leaflet holder**  
 Carton quantity 18  
 Opening dimensions: **160 x 32mm**  
 Crystal Clear Polystyrene

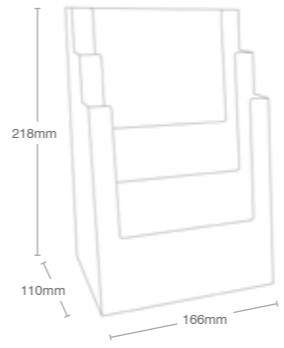

SIZE: A5



**4C160**  
**4 pocket A5 portrait leaflet holder**  
 Carton quantity 18  
 Opening dimensions: **160 x 32mm**  
 Crystal Clear Polystyrene

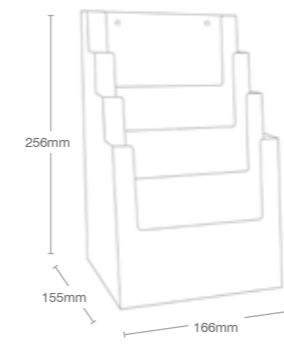

SIZE: A5



**4C330** - supplied with 8 removable CD pocket dividers  
**8 pocket A5 portrait leaflet holder**  
 Carton quantity 8  
 Opening dimensions: **160 x 32mm**  
 Crystal Clear Polystyrene

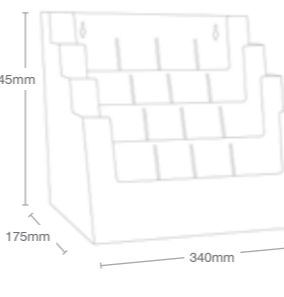

SIZE: A5



**TS160**  
**1 pocket A5 portrait leaflet holder**  
 Carton quantity 40  
 Pocket is open-ended and can accommodate oversized A5 leaflets. Pocket depth: 32mm  
 Crystal Clear Polystyrene

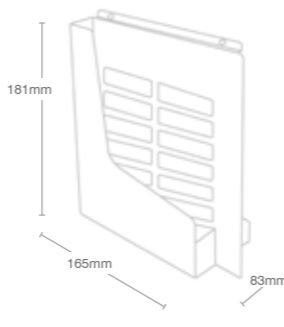

A6

SIZE: A6



**WLA6** - with removable AB1 counter stand clip  
**1 pocket A6 landscape leaflet holder**  
 Carton quantity 56  
 Opening dimensions: **160 x 32mm**  
 Crystal Clear Polystyrene

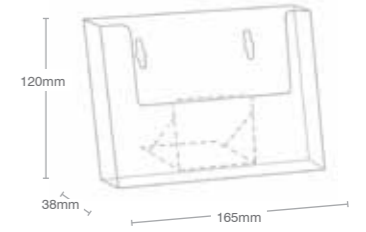

SIZE: A6



**WPA6** - with removable AB1 counter stand clip  
**1 pocket A6 portrait leaflet holder**  
 Carton quantity 80  
 Opening dimensions: **110 x 32mm**  
 Crystal Clear Polystyrene

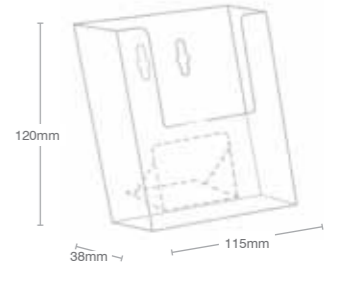

SIZE: A6



**2CA6**  
**2 pocket A6 portrait leaflet holder**  
 Carton quantity 48  
 Opening dimensions: **112 x 32mm**  
 Crystal Clear Polystyrene

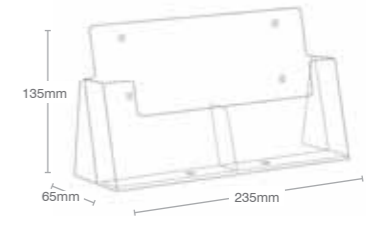

## 2. Wall Mounting - Taymar

Products to suit 1/3rd A4/DL, A5 & A4 literature for wall mounting display. Most of these products are also suitable for attaching to slat-wall and wire displays by using simple Taymar adaptor clips. Look also for the leaflet dispensers that are dual purpose wall mounting and counter standing.

Visit [www.brochureholders.com](http://www.brochureholders.com)

### 1/3<sup>rd</sup> A4 / DL

SIZE: 1/3rd A4/DL



**WL230**

1 pocket 1/3rd A4/DL landscape leaflet holder

Carton quantity 84  
Opening dimensions: **230 x 32mm**  
Crystal Clear Polystyrene

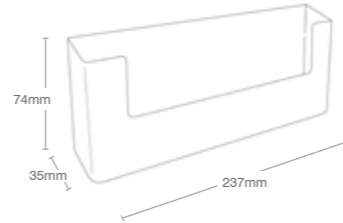

SIZE: 1/3rd A4/DL



**TS110**

1 pocket 1/3rd A4/DL portrait leaflet holder

Carton quantity 40  
Pocket is open-ended and can accommodate oversized 1/3rd A4/DL leaflets. Pocket depth: 32mm  
Crystal Clear Polystyrene

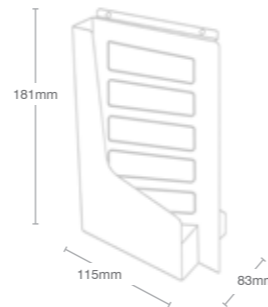

SIZE: 1/3rd A4/DL



**FP110**

1 pocket 1/3rd A4/DL flat pack leaflet holder

Carton quantity 100  
Opening dimensions: **110 x 32mm**  
Polypropylene

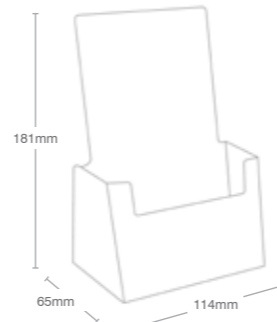

SIZE: 1/3rd A4/DL



**W110X**

1 pocket 1/3rd A4/DL portrait leaflet holder

Carton quantity 100  
Opening dimensions: **110 x 32mm**  
Crystal Clear Polystyrene

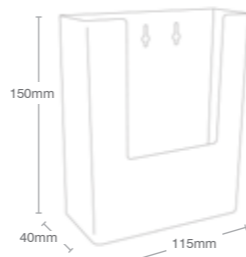

SIZE: 1/3rd A4



**3C104**

3 pocket 1/3rd A4 portrait leaflet holder

Carton quantity 20  
Opening dimensions: **104 x 32mm**  
Crystal Clear Polystyrene

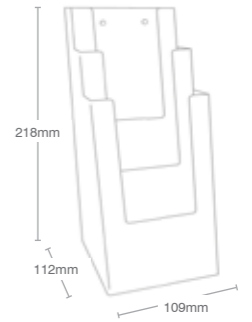

SIZE: 1/3rd A4/DL



**3W110H**

3 pocket 1/3rd A4/DL portrait leaflet holder

Carton quantity 36  
Opening dimensions: **110 x 32mm**  
Crystal Clear Polystyrene

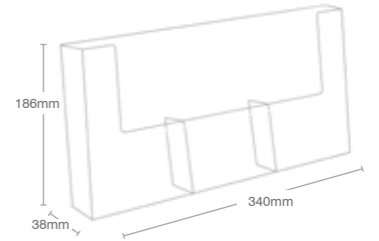

SIZE: 1/3rd A4



**4W104**

4 pocket 1/3rd A4 portrait leaflet holder

Carton quantity 24  
Opening dimensions: **104 x 32mm**  
Crystal Clear Polystyrene

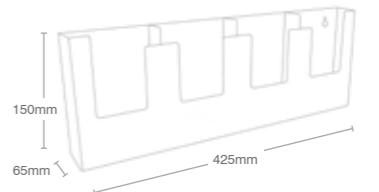

SIZE: 1/3rd A4/DL



**2C230** - supplied with 2 removable CD pocket dividers

4 pocket 1/3rd A4/DL portrait leaflet holder

Carton quantity 16  
Opening dimensions: **110 x 32mm**  
Crystal Clear Polystyrene

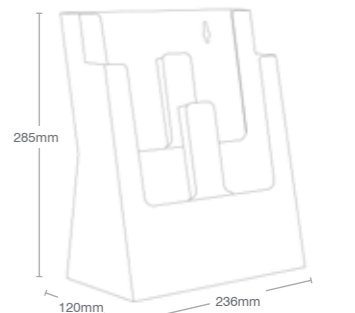

SIZE: 1/3rd A4/DL



**4C230** - supplied with 4 removable CD pocket dividers

8 pocket 1/3rd A4/DL portrait leaflet holder

Carton quantity 8  
Opening dimensions: **110 x 32mm**  
Crystal Clear Polystyrene

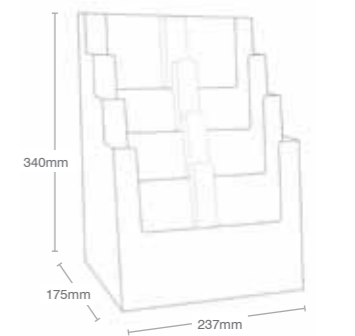

SIZE: 1/3rd A4/DL



**4C330** - supplied with 8 removable CD pocket dividers  
**12 pocket 1/3rd A4/DL portrait leaflet holder**  
 Carton quantity 8  
 Opening dimensions: **110 x 32mm**  
 Crystal Clear Polystyrene

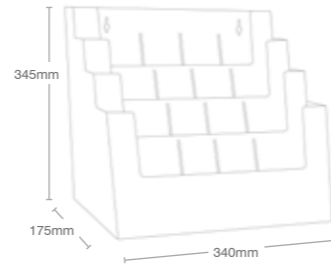

SIZE: A4



**2C230X**  
**2 pocket A4 portrait leaflet holder**  
 Carton quantity 16  
 Opening dimensions: **230 x 32mm**  
 Crystal Clear Polystyrene

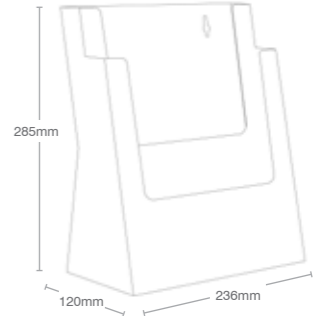

# A4

SIZE: A4



**W330**  
**1 pocket A4 landscape leaflet holder**  
 Carton quantity 36  
 Opening dimensions: **330 x 32mm**  
 Crystal Clear Polystyrene

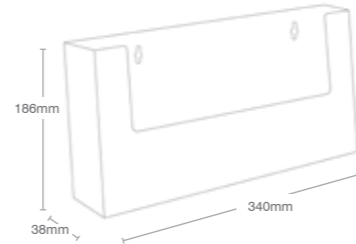

SIZE: A4



**4C330X**  
**4 pocket A4 landscape leaflet holder**  
 Carton quantity 8  
 Opening dimensions: **330 x 32mm**  
 Crystal Clear Polystyrene

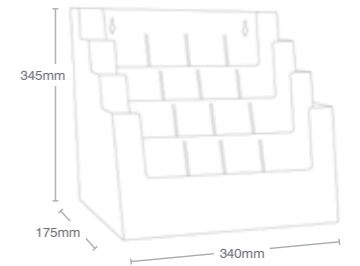

SIZE: A4



**W230X**  
**1 pocket A4 portrait leaflet holder**  
 Carton quantity 44  
 Opening dimensions: **230 x 32mm**  
 Crystal Clear Polystyrene

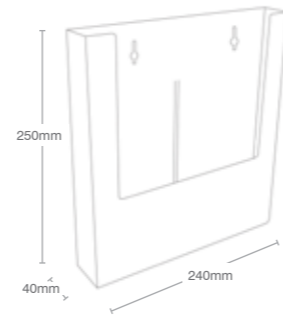

SIZE: A4



**4C230** - supplied with 4 removable CD pocket dividers  
**4 pocket A4 portrait leaflet holder**  
 Carton quantity 8  
 Opening dimensions: **230 x 32mm**  
 Crystal Clear Polystyrene

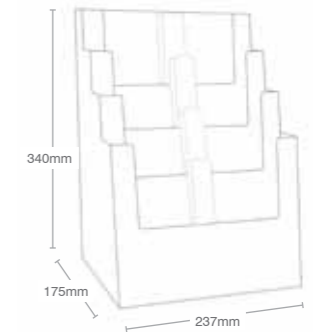

SIZE: A4



**TS230**  
**1 pocket A4 portrait leaflet holder**  
 Carton quantity 32  
 Pocket is open-ended and can accommodate oversized A4 leaflets. Pocket depth: 32mm  
 Crystal Clear Polystyrene

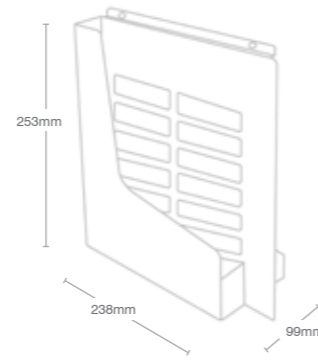

SIZE: A4



**4C230X**  
**4 pocket A4 portrait leaflet holder**  
 Carton quantity 8  
 Opening dimensions: **230 x 32mm**  
 Crystal Clear Polystyrene

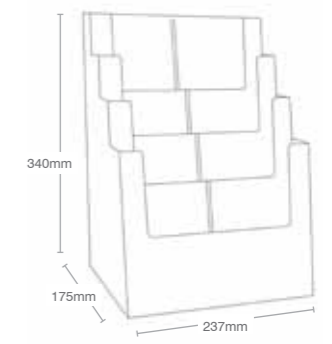

SIZE: A4



**3W230**  
**3 pocket A4 portrait leaflet holder**  
 Carton quantity 12  
 Opening dimensions: **230 x 32mm**  
 Crystal Clear Polystyrene

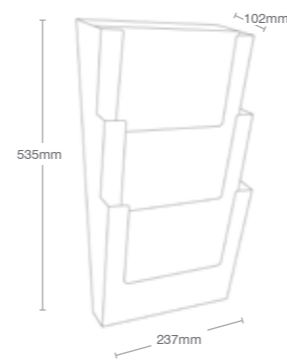

SIZE: A5

# A5



**WLA5**  
**1 pocket A5 landscape leaflet holder**  
 Carton quantity 84  
 Opening dimensions: **230 x 32mm**  
 Crystal Clear Polystyrene

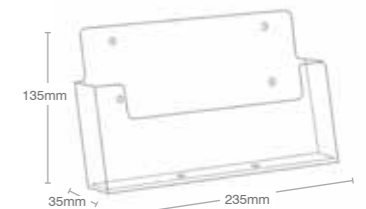



SIZE: A5



**TS160**

1 pocket A5 portrait leaflet holder

Carton quantity 40  
Pocket is open-ended and can accommodate oversized A5 leaflets. Pocket depth: 32mm  
Crystal Clear Polystyrene

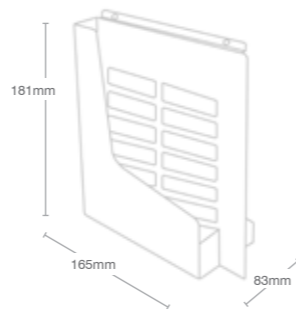

SIZE: A5



**2W155H**

2 pocket A5 portrait leaflet holder

Carton quantity 36  
Opening dimensions: **160 x 32mm**  
Crystal Clear Polystyrene

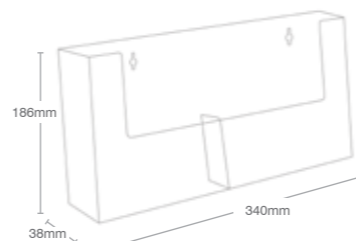

SIZE: A5



**W160X**

1 pocket A5 portrait leaflet holder

Carton quantity 88  
Opening dimensions: **160 x 32mm**  
Crystal Clear Polystyrene

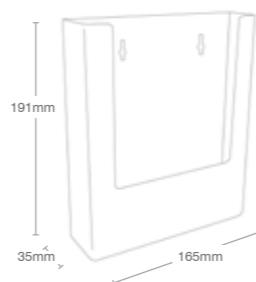

SIZE: A5



**2C160**

2 pocket A5 portrait leaflet holder

Carton quantity 24  
Opening dimensions: **160 x 48mm**  
Crystal Clear Polystyrene

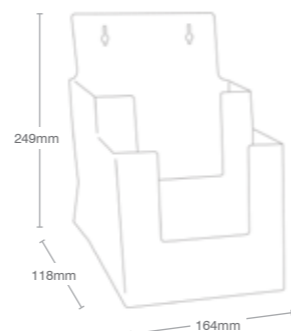

SIZE: A5



**3C160**

3 pocket A5 portrait leaflet holder

Carton quantity 18  
Opening dimensions: **160 x 32mm**  
Crystal Clear Polystyrene

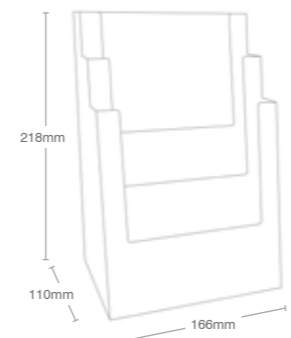

SIZE: A5



**4C160**

4 pocket A5 portrait leaflet holder

Carton quantity 18  
Opening dimensions: **160 x 32mm**  
Crystal Clear Polystyrene

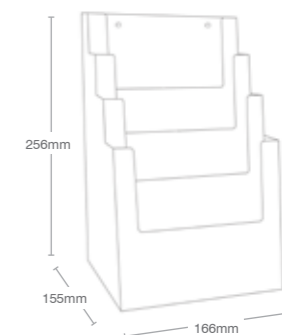

SIZE: A5



**4C330** - supplied with 8 removable CD pocket dividers

8 pocket A5 portrait leaflet holder

Carton quantity 8  
Opening dimensions: **330 x 32mm**  
Crystal Clear Polystyrene

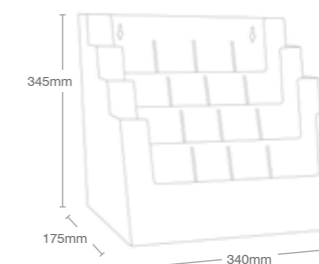

SIZE: A6

**A6**



**WLA6X**

1 pocket A6 landscape leaflet holder

Carton quantity 56  
Opening dimensions: **160 x 32mm**  
Crystal Clear Polystyrene

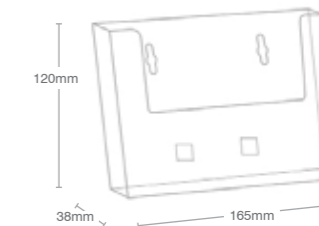

SIZE: A6



**WPA6X**

1 pocket A6 portrait leaflet holder

Carton quantity 80  
Opening dimensions: **110 x 32mm**  
Crystal Clear Polystyrene

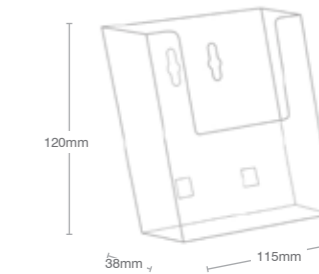

SIZE: A6



**2WA6**

2 pocket A6 portrait leaflet holder

Carton quantity 84  
Opening dimensions: **112 x 32mm**  
Crystal Clear Polystyrene

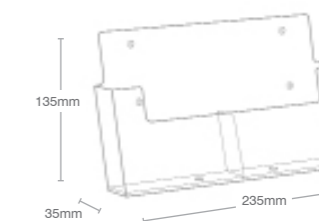

### 3. Wall Mounting - ClipLock

ClipLock leaflet holders to suit 1/3rd A4, A5 & A4 literature for wall mounting display. ClipLock pockets have keyholes running along the full rear panel providing for a variety of mounting options and configurations when used with ClipLock accessory clips. Please see the accessory pages to find more details.

Visit [www.brochureholders.com](http://www.brochureholders.com) for more information

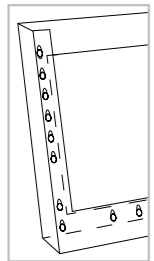

Keyholes run the length of the full rear panel. When connecting pockets in a column, joining clips can be positioned in higher or lower keyholes to achieve the desired pocket overlap.



Side joining clips (CL-SJC) can be used to join pockets of the same size to one another.

Down joining clips (CL-DJC) can be used to join pockets of different sizes to one another.

SIZE: A5



**CL-108**  
1 pocket 1/3rd A4 portrait leaflet holder  
Carton quantity 40  
Opening dimensions: **108 x 32mm**  
Crystal Clear Polystyrene

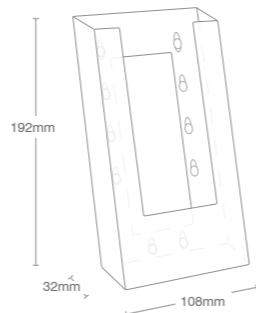

SIZE: A5



**CL-152**  
1 pocket A5 portrait leaflet holder  
Carton quantity 40  
Opening dimensions: **152 x 32mm**  
Crystal Clear Polystyrene

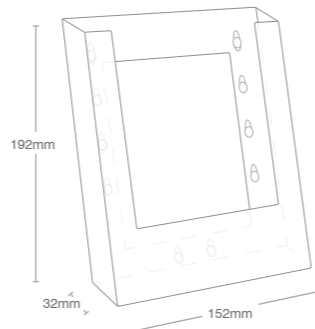

SIZE: A5



**CL-223**  
1 pocket A4 portrait leaflet holder  
Carton quantity 40  
Opening dimensions: **223 x 32mm**  
Crystal Clear Polystyrene

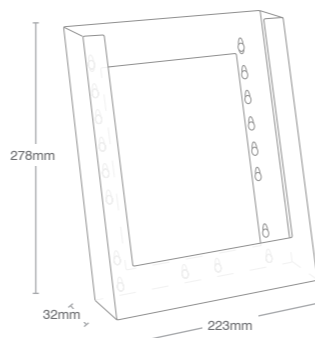

### 4. Business Card Holders

Taymar business card holders are offered in both landscape and portrait styles. As well as the ever popular single pocket version, both four and eight pocket versions are offered. Use the flat back or clip-on alternatives to attach to other products for maximum effect.

Visit [www.brochureholders.com](http://www.brochureholders.com)

#### BUSINESS CARD HOLDERS

Business Card Holders



**BC93**  
1 pocket landscape business card holder - counter standing  
Carton quantity 250  
Opening dimensions: **93 x 18mm**  
Crystal Clear Polystyrene

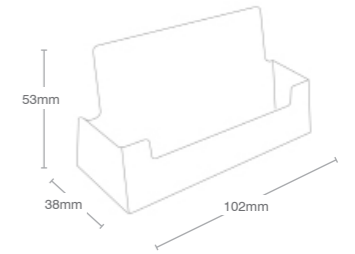

Business Card Holders



**WBC93**  
1 pocket landscape business card holder - wall mounting  
Carton quantity 250  
Opening dimensions: **93 x 18mm**  
Crystal Clear Polystyrene

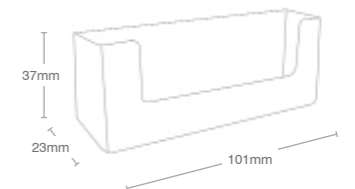

Business Card Holders



**CWBC93**  
1 pocket landscape clip-on business card holder  
Carton quantity 280  
Opening dimensions: **93 x 18mm**  
Crystal Clear Polystyrene

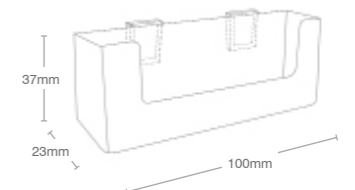

Business Card Holders



**NB93**  
1 pocket landscape business card holder - backless  
Carton quantity 130  
Opening dimensions: **93 x 18mm**  
Crystal Clear Polystyrene

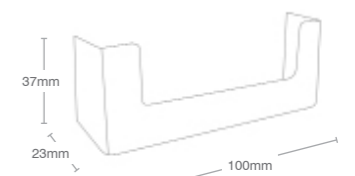

Business Card Holders



**VBC56**

1 pocket portrait business card holder  
- counter standing

Carton quantity 280  
Opening dimensions: 59 x 19mm  
Crystal Clear Polystyrene

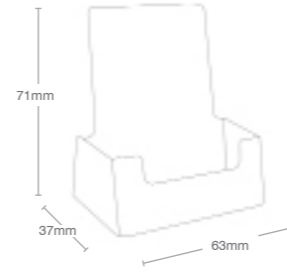

Business Card Holders



**4BC93**

4 pocket landscape business card holder  
- counter standing

Carton quantity 72  
Opening dimensions: 93 x 18mm  
Crystal Clear Polystyrene

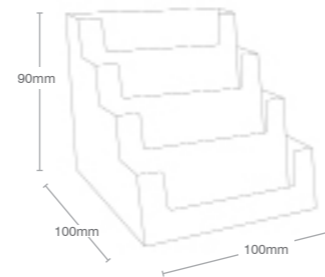

Business Card Holders



**8BC93**

8 pocket landscape business card holder  
- counter standing

Carton quantity 36  
Opening dimensions: 93 x 18mm  
Crystal Clear Polystyrene

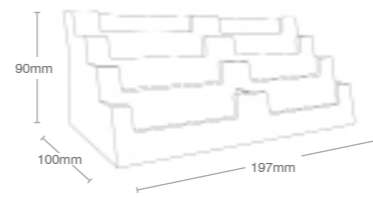

Business Card Holders



**OD95**

1 pocket landscape outdoor business card holder  
- wall mounting

Carton quantity 40  
Opening dimensions: 95 x 25mm  
Crystal Clear Polystyrene

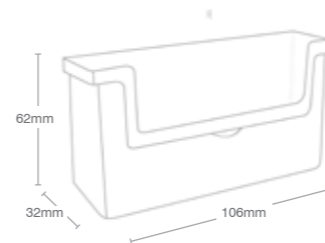

# 5. Single Page

A simple and extremely cost effective way to display your literature. Both single and double sided options are offered to suit 1/3rd A4, A5 & A4 leaflets, menus or pricing information. Simply slot your literature between the clear PVC cover that allows total protection and simplicity to change. Alternatively, the base only can be supplied for use with oversize or die-cut cards.

Check all of the options at [www.brochureholders.com](http://www.brochureholders.com)

## BASE ONLY

Base Only



**L100B**

1/3rd A4 Angled information holder base only

Carton quantity 260  
Crystal Clear Polystyrene

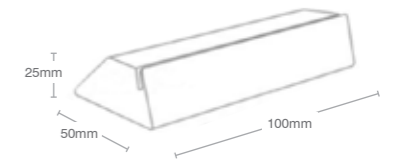

Base Only



**L150B**

A5 Angled information holder base only

Carton quantity 100  
Crystal Clear Polystyrene

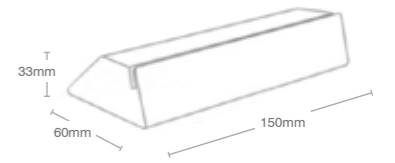

Base Only



**L210B**

A4 Angled information holder base only

Carton quantity 50  
Crystal Clear Polystyrene

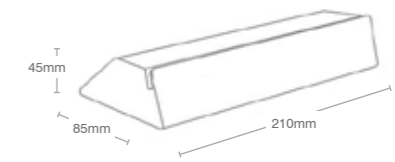

Base Only



**M120B**

120mm Menu holder base only

Carton quantity 256  
Crystal Clear Polystyrene

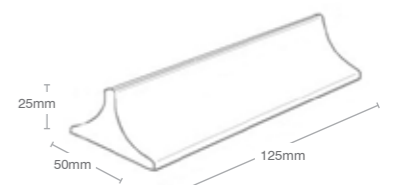

Base Only



**M160B**  
A5 Menu holder base only  
Carton quantity 192  
Crystal Clear Polystyrene

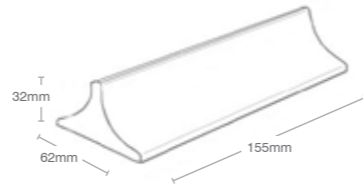

Base Only



**PC260**  
Place card holder 80mm wide  
Carton quantity 140  
Crystal Clear Polystyrene

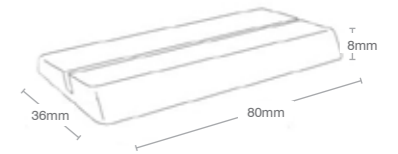

Base Only



**M210B**  
A4 Menu holder base only  
Carton quantity 96  
Crystal Clear Polystyrene

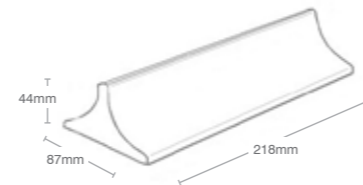

Base & PVC Top



**L100**  
1/3rd A4 Angled information holder with PVC  
Carton quantity 200  
to hold: 210 x 100mm  
Base: Crystal Clear Polystyrene - Top: PVC

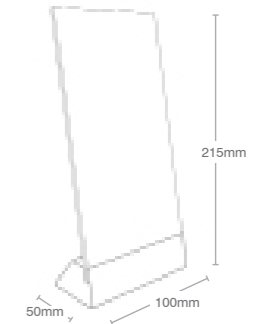

Base Only



**V100B**  
1/3rd A4 Menu holder base only  
Carton quantity 260  
Crystal Clear Polystyrene

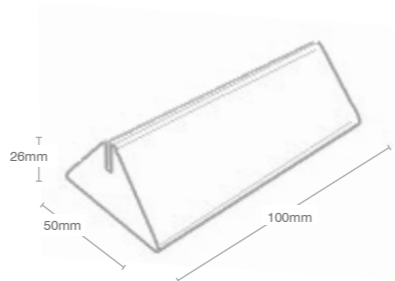

Base & PVC Top



**V100**  
1/3rd A4 Menu holder with PVC  
Carton quantity 200  
to hold: 210 x 100mm  
Base: Crystal Clear Polystyrene - Top: PVC

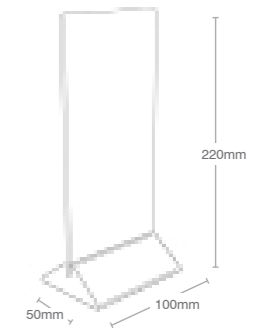

Base Only



**V150B**  
A5 Menu holder base only  
Carton quantity 100  
Crystal Clear Polystyrene

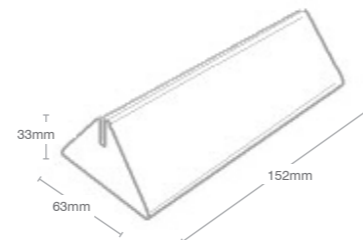

Base & PVC Top



**M120**  
120mm Menu holder with PVC  
Carton quantity 192  
to hold: 135 x 120mm  
Base: Crystal Clear Polystyrene - Top: PVC

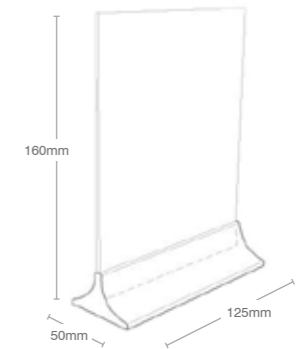

Base Only



**V210B**  
A4 Menu holder base only  
Carton quantity 50  
Crystal Clear Polystyrene

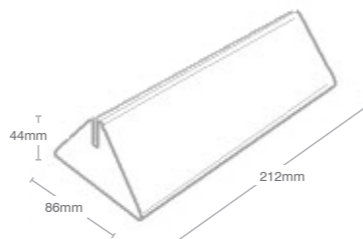

Base & PVC Top



**AP150**  
A5 Angled ad-print with PVC  
Carton quantity 60  
to hold: 210 x 148mm  
Base: Crystal Clear Polystyrene - Insert: PVC

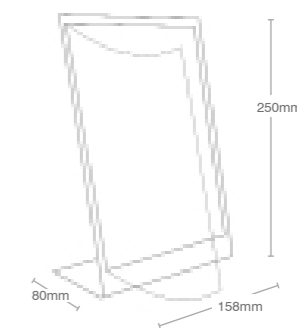

Base & PVC Top



**L150**

A5 Angled information holder with PVC

Carton quantity 80  
to hold: 210 x 148mm  
Base: Crystal Clear Polystyrene - Top: PVC

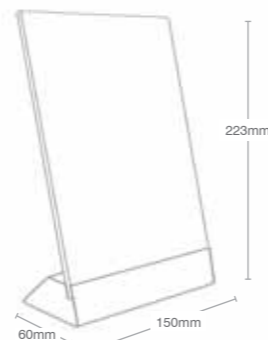

Base & PVC Top



**V210**

A4 Menu holder with PVC

Carton quantity 40  
to hold: 297 x 210mm  
Base: Crystal Clear Polystyrene - Top: PETG



Base & PVC Top



**V150**

A5 Menu holder with PVC

Carton quantity 80  
to hold: 210 x 148mm  
Base: Crystal Clear Polystyrene - Top: PVC



Base & PVC Top



**M210**

A4 Menu holder with PVC

Carton quantity 72  
to hold: 297 x 210mm  
Base: Crystal Clear Polystyrene - Top: PETG

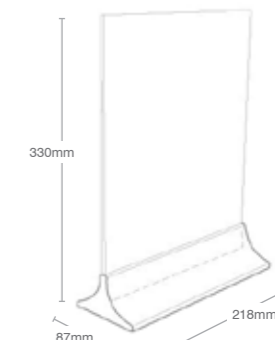

Base & PVC Top



**M160**

A5 Menu holder with PVC

Carton quantity 144  
to hold: 210 x 150mm  
Base: Crystal Clear Polystyrene - Top: PVC

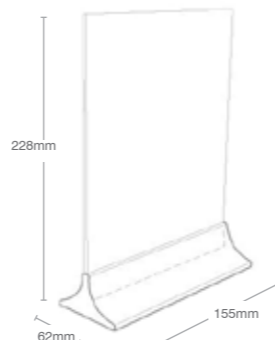

Base & PVC Top



**NH210**

A4 Notice holder with PVC - double sided  
- window/wall mount - supplied with adhesive pads

Carton quantity 30  
to hold: 297 x 210mm  
Base: Crystal Clear Polystyrene - Insert: PVC

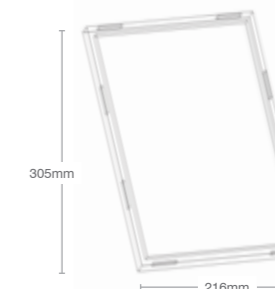

Base & PVC Top



**AP210**

A4 Angled ad-print with PVC

Carton quantity 60  
to hold: 297 x 210mm  
Base: Crystal Clear Polystyrene - Insert: PVC

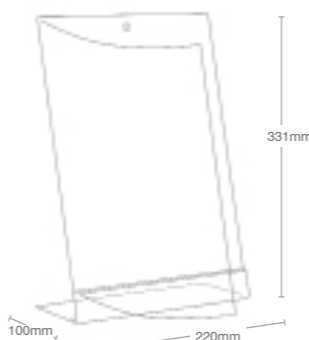

Base & PVC Top



**L210**

A4 Angled information holder with PVC

Carton quantity 40  
to hold: 297 x 210mm  
Base: Crystal Clear Polystyrene - Top: PETG

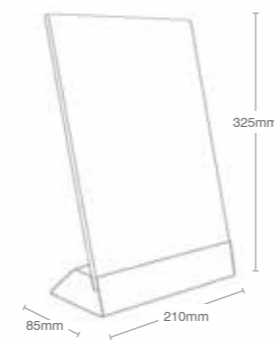

## 6. Outdoor Leaflet Holders

A range of outdoor leaflet holders designed to suit all popular paper sizes. Weather and UV resistant.

Visit [www.brochureholders.com](http://www.brochureholders.com) for further details.

### OUTDOOR HOLDERS

Outdoor



#### OD95

1 pocket landscape outdoor business card holder

Carton quantity 40  
Opening dimensions: 95 x 25mm  
Crystal Clear Polystyrene

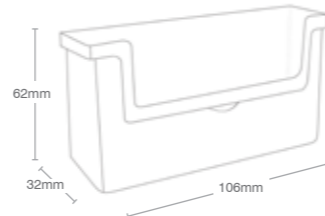

Outdoor



#### OD110

1 pocket 1/3rd A4/DL outdoor leaflet holder

Carton quantity 18  
Opening dimensions: 110 x 32mm  
Crystal Clear Polystyrene

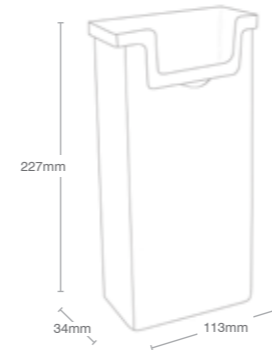

Outdoor



#### OD160

1 pocket A5 outdoor leaflet holder

Carton quantity 20  
Opening dimensions: 160 x 32mm  
Crystal Clear Polystyrene

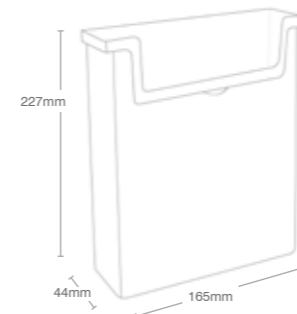

Outdoor



#### OD230

1 pocket A4 outdoor leaflet holder

Carton quantity 20  
Opening dimensions: 230 x 32mm  
Crystal Clear Polystyrene

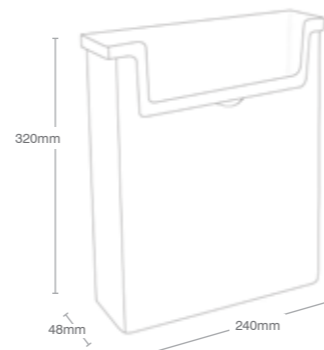

## 7. Floor Standing Carousels

A cleverly designed selection of rotary floor standing leaflet dispensers offering maximum versatility at minimum price. Choose from the contemporary and flexible 'mix and match' model or the traditional 'Classic' Taymar carousel.

Visit [www.brochureholders.com](http://www.brochureholders.com) to see the full range of floor standing carousels.

### CAROUSELS

Carousels



#### 12RC230F

12 pocket A4 carousel

Opening dimensions: 230 x 32mm  
Pockets: Crystal Clear Polystyrene

CD Pocket Dividers available separately to convert pockets to 1/3rd A4/DL (Image 2)

Image 1



Image 2

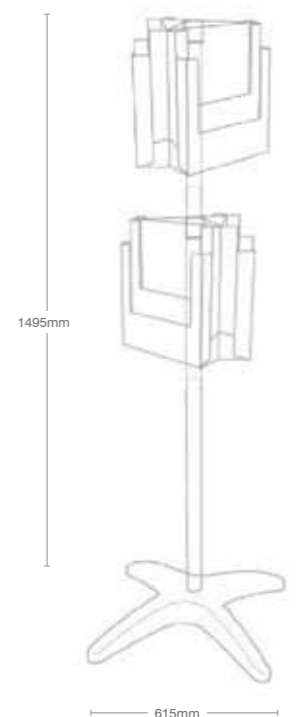

Carousels



**MSC2**

'Mix and Match' carousel with any 2 tier combination - choose from:

- 12 Pocket 1/3rd A4 tier
- 6 pocket A4 tier
- 6 pocket A5 tier

Pockets: Crystal Clear Polystyrene

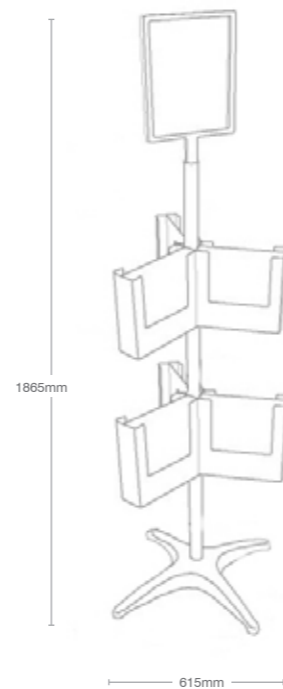

Carousels



**12F230**

12 pocket A4 'Classic' carousel

Opening dimensions: 230 x 32mm  
Pockets: Crystal Clear Polystyrene

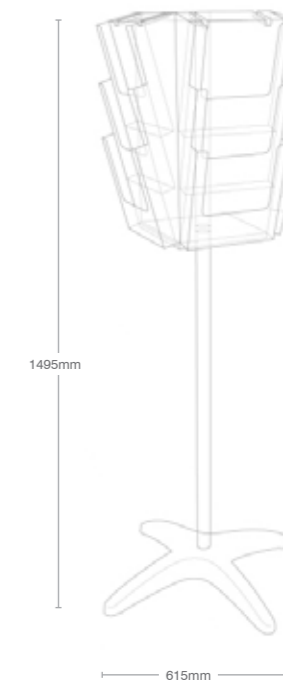

Carousels



**CA1**

'Mix and Match' carousel with any 3 tier combination - choose from:

- 12 Pocket 1/3rd A4 tier
- 6 pocket A4 tier
- 6 pocket A5 tier

Optional CAP210 A4 header available - see p. 26  
Pockets: Crystal Clear Polystyrene

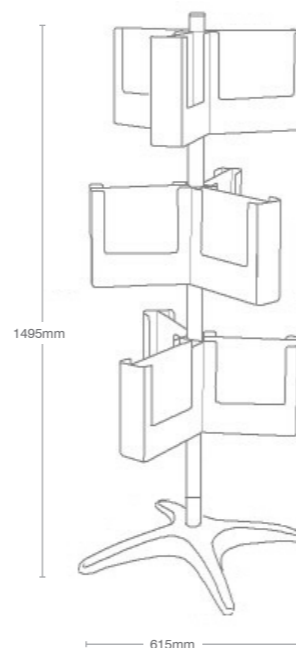

Carousels



**24F230**

24 pocket A4 'Classic' carousel

Opening dimensions: 230 x 32mm  
Pockets: Crystal Clear Polystyrene

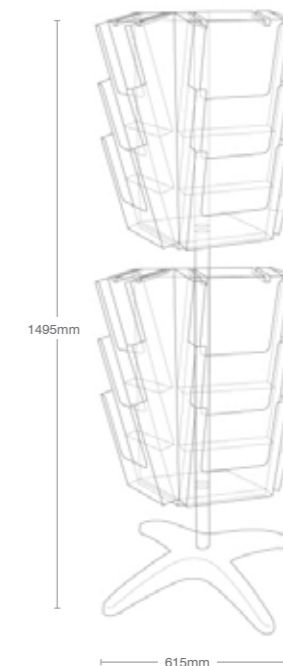

Carousels



**6RC230**

Additional tier for 12RC230F  
Opening dimensions: **230 x 32mm**  
Crystal Clear Polystyrene

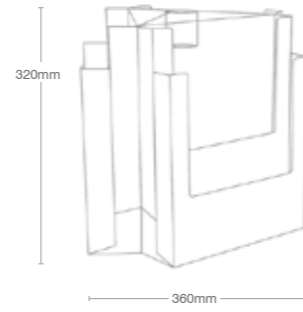

Carousels



**12CA104**

Additional 1/3rd A4 tier for CA1 or MSC kits  
Opening dimensions: **104 x 32mm**  
Crystal Clear Polystyrene

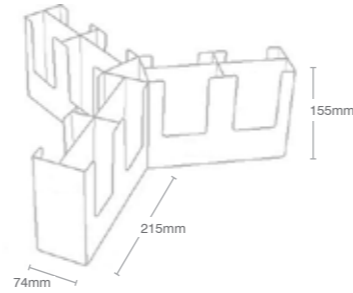

Carousels



**6CA230**

Additional A4 tier for CA1 or MSC kits  
Opening dimensions: **230 x 32mm**  
Crystal Clear Polystyrene

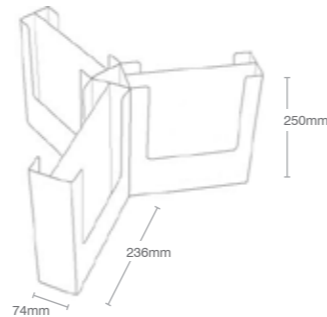

Carousels



**6CA160**

Additional A5 tier for CA1 or MSC kits  
Opening dimensions: **160 x 32mm**  
Crystal Clear Polystyrene

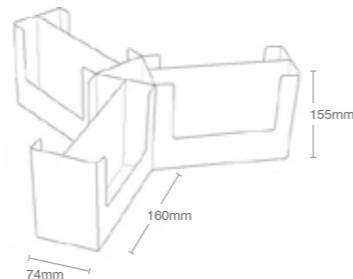

Carousels



**CAP210**

Optional A4 header for use with CA1  
to hold: **297 x 210mm**  
Frame: Polystyrene - Insert: PVC

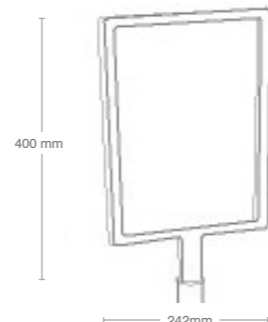

# 8. Desktop Spinners - Taymar

An eye-catching range of desktop spinners for 1/3rd A4, A5 and A5 literature. Each A4 spinner is compatible with our removable pocket dividers allowing pockets to be converted to 1/3rd A4 if required. Choose from three, four, six, or twelve pocket models.

Visit [www.brochureholders.com](http://www.brochureholders.com) to see the full range of desktop spinners.

## TAYMAR DESKTOP SPINNERS

Desktop Spinners



**6RC230C**

6 pocket A4 desktop carousel  
Opening dimensions: **230 x 32mm**  
Pockets: Crystal Clear Polystyrene

CD Pocket Dividers available separately to convert pockets to 1/3rd A4/DL

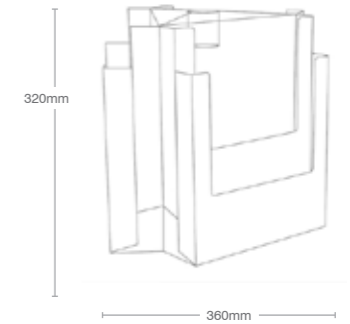

Desktop Spinners



**12C230**

12 pocket A4 desktop carousel  
Opening dimensions: **230 x 32mm**  
Pockets: Crystal Clear Polystyrene

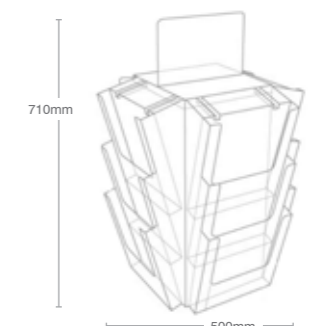



# 9. Desktop Spinners - ClipLock

An attractive selection of desktop spinners available for 1/3rd A4, A5 and A4 literature with three and four pocket models. Our competitively priced ClipLock spinners are supplied in kit form and are incredibly straight forward to assemble.

Visit [www.brochureholders.com](http://www.brochureholders.com) to see the full range of desktop spinners.



**Assembly:**

Each ClipLock spinner is supplied with all components and easy to follow instructions. Assembly takes no more than a couple of minutes.

The pockets are joined together using 'coupling clips' (image 1) and fixed to the spinner base using 'angled joining clips' (image 2).

Image 1

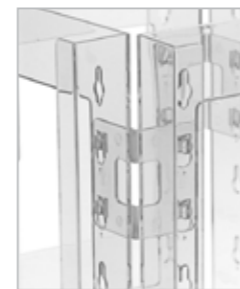

Image 2



## CLIPLOCK DESKTOP SPINNERS

Desktop Spinners



**CL-RS3108**

3 pocket 1/3rd A4 desktop spinner

Opening dimensions: 108 x 32mm  
Pockets: Crystal Clear Polystyrene

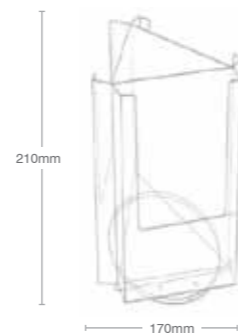

Desktop Spinners



**CL-RS3152**

3 pocket A5 desktop spinner

Opening dimensions: 152 x 32mm  
Pockets: Crystal Clear Polystyrene

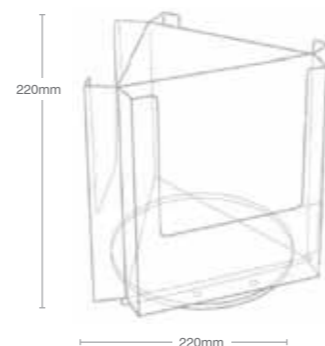

Desktop Spinners



**CL-RS3223**

3 pocket A4 desktop spinner

Opening dimensions: 223 x 32mm  
Pockets: Crystal Clear Polystyrene

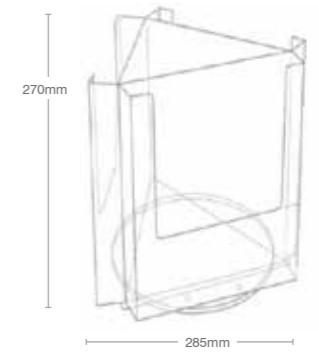

Desktop Spinners

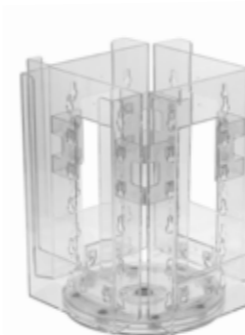

**CL-RS4108**

4 pocket 1/3rd A4/DL desktop spinner

Opening dimensions: 108 x 32mm  
Pockets: Crystal Clear Polystyrene

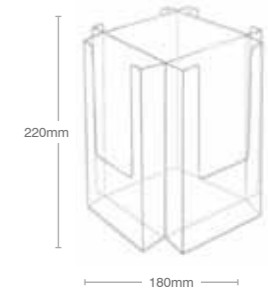

Desktop Spinners

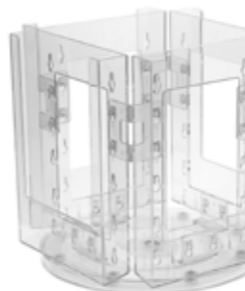

**CL-RS4152**

4 pocket A5 desktop spinner

Opening dimensions: 152 x 32mm  
Pockets: Crystal Clear Polystyrene

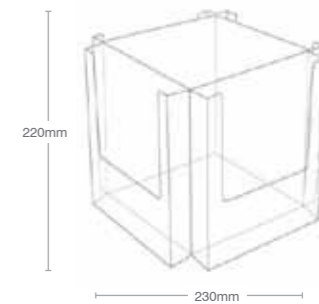

Desktop Spinners



**CL-RS4223**

4 pocket A4 desktop spinner

Opening dimensions: 223 x 32mm  
Pockets: Crystal Clear Polystyrene

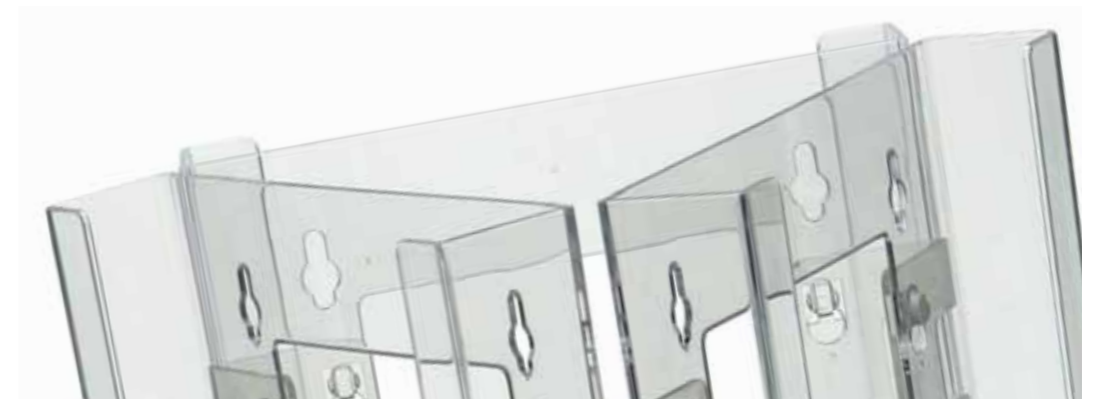
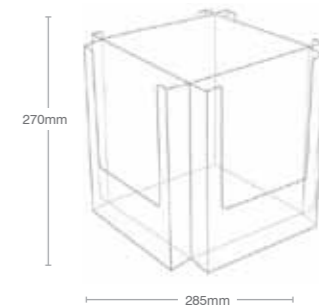

# 10. Floor Stands

A collection of floor standing display solutions. Completely free-standing and with a small footprint, Taymar floor stands can be positioned easily where required, ensuring maximum visual impact. Choose from a variety of models to suit 1/3rd A4, A5 and A4 literature.

Visit [www.brochureholders.com](http://www.brochureholders.com) for further details.



**Assembly:**

Each floor stand is supplied in three sections - The brochure holder (with T-bar already applied), the stand and the base. Simply insert the pieces together and secure with the bolts / toggles provided. All fixings are supplied.

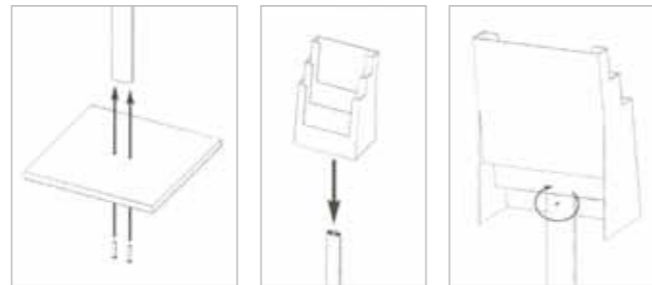

## LUXURY FLOOR STANDS

Floor Stands



**AS3104**  
Luxury floor stand - 3 x 1/3rd A4 pockets

Opening dimensions: 104 x 32mm  
Pockets: Crystal Clear Polystyrene

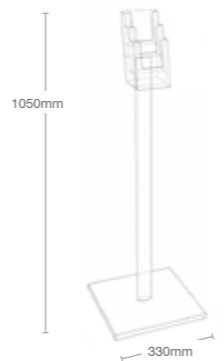

1050mm  
330mm

Floor Stands



**AS4110**  
Luxury floor stand - 4 x 1/3rd A4/DL pockets

Opening dimensions: 110 x 32mm  
Pockets: Crystal Clear Polystyrene

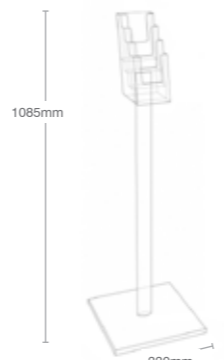

1085mm  
330mm

Floor Stands



**AS3160**  
Luxury floor stand - 3 x A5 pockets

Opening dimensions: 160 x 32mm  
Pockets: Crystal Clear Polystyrene

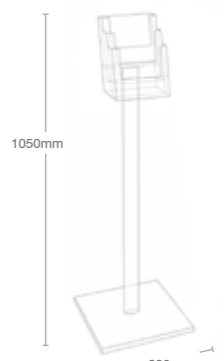

1050mm  
330mm

Floor Stands



**AS4160**  
Luxury floor stand - 4 x A5 pockets

Opening dimensions: 160 x 32mm  
Pockets: Crystal Clear Polystyrene

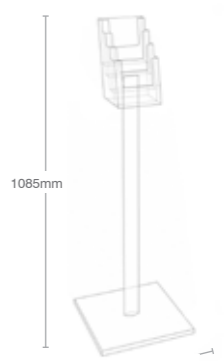

1085mm  
330mm

Floor Stands



**AS3230**  
Luxury floor stand - 3 x A4 pockets - dividers available

Opening dimensions: 230 x 32mm  
Pockets: Crystal Clear Polystyrene

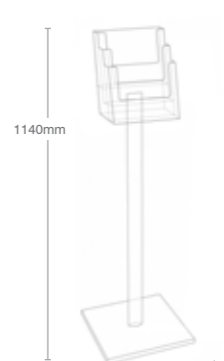

1140mm  
330mm

Floor Stands



**AS4230**  
Luxury floor stand - 4 x A4 pockets - dividers available

Opening dimensions: 230 x 32mm  
Pockets: Crystal Clear Polystyrene

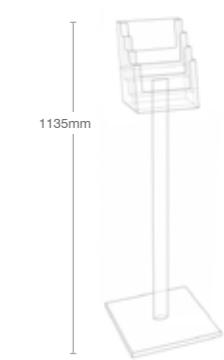

1135mm  
330mm

Floor Stands



**AS330**  
Luxury floor stand - 1 x A4 pocket - landscape

Opening dimensions: 330 x 32mm  
Pockets: Crystal Clear Polystyrene

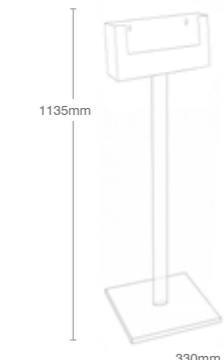

1135mm  
330mm

Floor Stands



**AS2155**  
 Luxury floor stand - 2 x A5 pockets - side by side  
 Opening dimensions: 160 x 32mm  
 Pockets: Crystal Clear Polystyrene

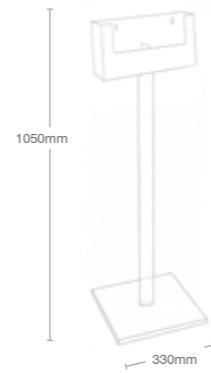

Floor Stands



**AS3110**  
 Luxury floor stand - 2 x 1/3rd A4 pockets - side by side  
 Opening dimensions: 110 x 32mm  
 Pockets: Crystal Clear Polystyrene

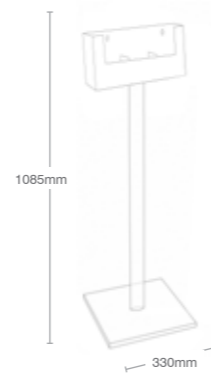

Floor Stands



**ASP210**  
 Luxury floor stand - A4 notice holder  
 To Hold: 1 x A4 Notice  
 Pockets: Crystal Clear Polystyrene

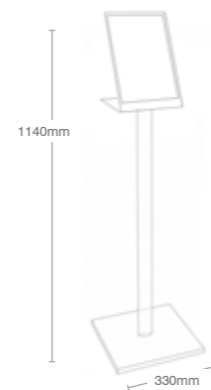

# 11. Wall System - Taymar

Probably the most ingenious and cost effective method to display all literature - even the most unusual paper sizes! Fully adjustable in width with versions for attaching directly to slat-wall or for use with our own wall strip (CL-PL-46). Alternatively, opt for the ready made kit system that is both easy to install and with stunning effect.

More details available by visiting [www.brochureholders.com](http://www.brochureholders.com)

Wall System



## Wall System

3 pocket adjustable width holders

Carton quantity 60 | Opening dimensions: 32mm  
 Pockets: Crystal Clear Polystyrene

### 3PSW

3 pocket adjustable width holder stat-wall fitting

### 3PAS

3 pocket adjustable width holder CL-PL-46 fitting

### Unique Adjustable Wall Mounting System

A superb, innovative product allowing for infinite flexibility in displaying your literature.

A product which can be set up to hold any size material, this system has the bonus that single pieces can be added on as required, with each additional module creating an extra 3 pocket display at less than half the cost of a standard brochure holder. This unique system has been developed for use in all types of locations, especially where wall space is limited.

#### Two versions have been developed:

**3PAS** - for use with our unique clip-on wall strip, CL-PL-46. This system can turn whole walls into an adjustable display system which can be changed to accommodate any size material - standard or not - at any time. Simply screw the wall rail to wall or display board through the holes provided.

**3PSW** - for use with slat-wall displays; modules clip into standard slat and slides to the required position.

Each additional module provides 3 more pockets

#### Example:

Just 5 modules on the 95cm (37") strip provides a 12 pocket display of A4 (letterhead) size literature.  
 9 modules allows for a 24 pocket display of 1/3rd A4 (trifold) literature.  
 7 modules for an 18 pocket display of A5 (1/2 letterhead) literature.  
 Or mix and match to display you literature to maximum advantage

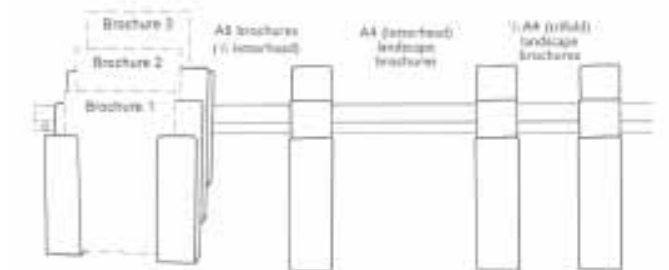

Wall System



### WS16-D8

A4 Wall-mounting kit providing 16 x A4  
 or 8 x A4 + 16 x 1/3rd A4 pockets

# 12. Wall Systems - ClipLock

Whether you are looking for a striking wall display for your literature, or simply need to make the best use of limited space, ClipLock has the answer. ClipLock wall display kits are a hassle free solution to wall mounted literature display. Fully height adjustable and available for 1/3rd A4, A5, A4 and combination paper sizes.

What's more, this innovative system is totally modular so extending existing displays by adding more pockets is easily done at any time. It is also possible to create totally bespoke displays.

More details available by visiting [www.brochureholders.com](http://www.brochureholders.com)

Wall System



### CL-KIT1

8 x A4 Pocket Wall Display Kit

Pocket Opening Dimensions: 223 x 32mm

Pockets: Crystal Clear Polystyrene

(a) Max. Height = 820mm / Min. Height = 510mm  
Adjust height by selecting different keyholes when joining pockets.

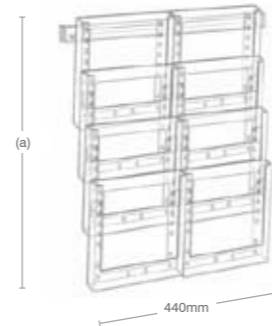

Wall System



### CL-KIT2

12 x A5 Pocket Wall Display Kit

Pocket Opening Dimensions: 147 x 32mm

Pockets: Crystal Clear Polystyrene

(a) Max. Height = 500mm / Min. Height = 310mm  
Adjust height by selecting different keyholes when joining pockets.

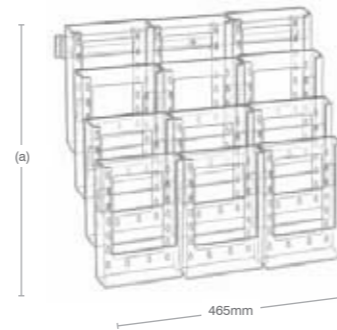

Wall System



### CL-KIT3

16 x 1/3rd A4 Pocket Wall Display Kit

Pocket Opening Dimensions: 108 x 32mm

Pockets: Crystal Clear Polystyrene

(a) Max. Height = 500mm / Min. Height = 310mm  
Adjust height by selecting different keyholes when joining pockets.

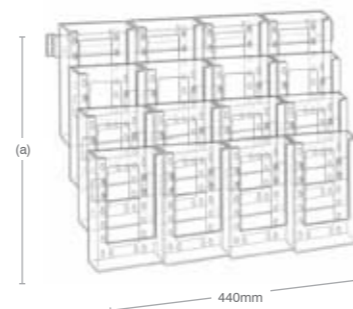

Wall System



### CL-KIT4

4 x A4 and 8 x 1/3rd A4 Pocket Wall Display Kit

Pocket Opening Dimensions:

223 x 32mm and 108 x 32mm

Pockets: Crystal Clear Polystyrene

(a) Max. Height = 700mm / Min. Height = 450mm  
Adjust height by selecting different keyholes when joining pockets.

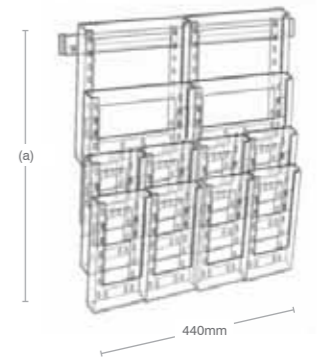

Wall System



### CL-KIT5

16 x A4 Pocket Wall Display Kit

Pocket Opening Dimensions: 223 x 32mm

Pockets: Crystal Clear Polystyrene

(a) Max. Height = 1640mm / Min. Height = 1020mm  
Adjust height by selecting different keyholes when joining pockets.

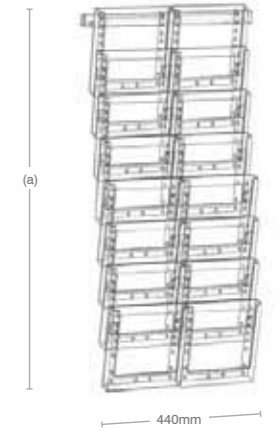

Wall System



### CL-KIT6

36 x A5 Pocket Wall Display Kit

Pocket Opening Dimensions: 152 x 32mm

Pockets: Crystal Clear Polystyrene

(a) Max. Height = 1500mm / Min. Height = 930mm  
Adjust height by selecting different keyholes when joining pockets.

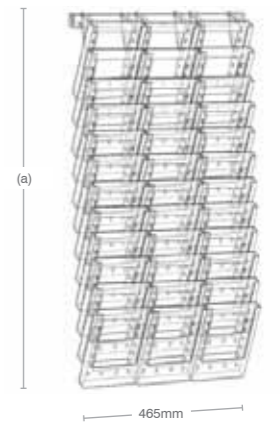

Wall System



### CL-KIT7

48 x 1/3rd A4 Pocket Wall Display Kit

Pocket Opening Dimensions: 108 x 32mm

Pockets: Crystal Clear Polystyrene

(a) Max. Height = 1380mm / Min. Height = 930mm  
Adjust height by selecting different keyholes when joining pockets.

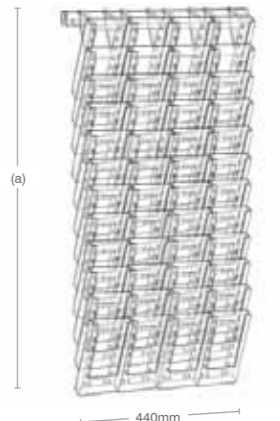

# 13. Accessories & Parts

Through clever use of simple adaptor clips, Taymar products become increasingly versatile. Easy to convert wall mounting holders for counter standing or to attach to slat-wall or to one another.

To see all options visit [www.brochureholders.com](http://www.brochureholders.com)

## CLIPS & ACCESSORIES

Clips		<p><b>AB1</b> Free-standing clip for use on 4W104, W110, W160 &amp; W230 Crystal Clear Polystyrene</p>	
Accessories		<p><b>CD</b> Pocket divider used to divide A4 portrait/landscape pockets Crystal Clear Polystyrene</p>	
Clips		<p><b>CLW</b> Clip on clips used to hang products from one another or CL-PL-46 (maximum 3 products) Polypropylene</p>	
Clips		<p><b>SWB1</b> Slat-wall clips used to attach wall mounted products (with keyholes) to slat-wall Crystal Clear Polystyrene</p>	
Clips		<p><b>HB1</b> Hanging clips used to hang wall mounted products (with keyholes) from wire frames or baskets Polypropylene</p>	
Clips		<p><b>CL-HC</b> Car window hanging clips used to hang OD products from car window. Polycarbonate</p>	

Clips		<p><b>CL-SJC</b> Side joining clips used to connect ClipLock pockets of the same size to one another. Polycarbonate</p>	
Clips		<p><b>CL-DJC</b> Down joining clips used to hang ClipLock pockets to one another. Can be used for pockets of the same size or pockets of different sizes. Polycarbonate</p>	
Accessories		<p><b>CL-PL-46</b> 460mm wall rail. Used with either Taymar pockets and CLW clips or ClipLock pockets with CL-MC or CL-LC mounting clips. Carton quantity 20 Polycarbonate</p>	
Clips		<p><b>CL-MC</b> Mounting clips used to hang ClipLock pockets to CL-PL-46 wall rail or CL-HEX brackets. Polycarbonate</p>	
Accessories		<p><b>CL-LC</b> Leaning mounting clips used to hang ClipLock pockets to CL-PL-46 wall rail or CL-HEX brackets creating a leaning display. Polycarbonate</p>	
Clips		<p><b>CL-SMC</b> Surface mounting clips. Fixed to window / wall using adhesive OD products can be then be mounted and removed from clip. Crystal Clear Polystyrene</p>	
Clips		<p><b>CL-LKB</b> Leaning mounting clips used to secure ClipLock pockets directly to the wall creating a leaning display. Polycarbonate</p>	
Clips		<p><b>CL-VSC</b> Slatwall mounting clips used to hang ClipLock pockets to slatwall displays Polycarbonate</p>	

Clips



**CL-LSB**

Leaning slatwall mounting clips used to hang ClipLock pockets to slatwall displays creating a leaning display.

Polycarbonate



Clips



**CL-SB**

Supporting bracket for ClipLock wall systems. Provides support for columns of 3 or more ClipLock pockets.

Polycarbonate



Clips



**CL-BSC**

Base securing clips. Used to provide additional support for ClipLock wall displays by fixing near the base of the display and screwing to the wall.

Polycarbonate



Clips



**CL-AJC**

Angle joining clip. Used to secure ClipLock pockets and 6RC230 to Lazy susan spinners.

Polycarbonate

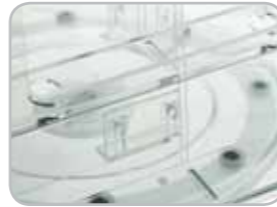

Clips



**CL-CC**

Coupling clips. Used to join ClipLock pockets together before bending into shape to create ClipLock desktop spinners.

K-Resin



Clips



**TSRC**

Thumb screw ring clip for securing floor standing carousel components in place on the carousel pole.

Polycarbonate



Accessories

**LS101**

100mm Lazy Susan



**LS145**

145mm Lazy Susan



**LS225**

225mm Lazy Susan



# 14. Screen Printing & Vinyl Labels

Add that little bit extra to your display!

Personalise holders with your company logo, a message or advertising slogan. We can offer you a customised printing service to apply your message, slogan or logo directly onto the brochure/information holder of your choice. The service includes Screen Printing or Vinyl Labels, both of which are fantastic ways to personalise Taymar products and achieve fantastic results.

**Printing Areas**

The following pages show the maximum screen printing area of each product in the Taymar range. In most cases, vinyl labels have slightly more flexibility and can also be applied to the sides of units as well.

**Requirements**

We are PC based. MAC files should be saved in PC format. Most common design and graphics programmes are supported. All fonts must be converted to curves, paths or outlines (Vector files). This avoids font matching and resolution problems and enables us to apply trapping or to make modifications to suit screen process print.

EPS & TIF Files: TIF files must be provided to highest possible resolution and should be at least 1200dpi. For line work all colours should be set as Pantone spot colours and not as CMYK.

Portable Document Files (PDF): PDF files are supported and all fonts must be converted to curves etc as above.

GIF – JPEG – BMP & Word files: GIF - JPEG - BMP and Word files are not acceptable for use as artwork. These files are normally not suitable for reproduction.

Camera ready Artwork: Camera ready artwork can be accepted but this will be scanned and converted to an electronic file.

**Brochure Holder & Leaflet Holder Artwork Preparation**

It is preferable to supply line artwork for these products but this does not rule out halftone or four colour process work provided the design allows for any screen resolution restrictions. We suggest that any tints are between 30% and 70%.

It is advisable to check the compatibility of your programmes with us before dispatching artwork. However, provided it is supplied as a vector file with all fonts converted to outlines there should not be a problem. Please ensure a proof is supplied showing any special instructions. Artwork should be adapted to suit screen process printing. Colour separations, trapping, order of printing colours can be significantly different to lithographic printing.

**Brochure Holders & Colour Matching**

Certain colours may appear slightly transparent when printed on to clear products. This is due to the pigments used in the manufacture of the inks. In many cases a background colour, such as White, will have to be printed.

**Colour Matching**

We use the Pantone reference system. If a reference colour is not available then a suitable swatch should be supplied. Adjustments have to be made to suit the substrate.

Products with this printable area:

**C110**

Products with this printable area:

**2CA6  
2WA6  
CLA5  
WLA5**

Products with this printable area:

**CL230  
WL230**

Products with this printable area:

**WPA6  
WPA6X**

Products with this printable area:

**C160**

Products with this printable area:

**4C330  
4C330X**

Products with this printable area:

**WLA6  
WLA6X**

Products with this printable area:

**W330  
3W110H  
2W155H**

Products with this printable area:

**C230  
2C112**

Products with this printable area:

**4C110**

Products with this printable area:

**W110  
W110X**

Products with this printable area:

**4W104**

Products with this printable area:

**2C230  
2C230X  
3C230  
4C230  
4C230X**

Products with this printable area:

**2C160  
3C160  
4C160**

Products with this printable area:

**W160  
W160X**

Products with this printable area:

**BC93**

Products with this printable area:

**C330  
3C110H  
2C155H**

Products with this printable area:

**2C110  
3C104**

Products with this printable area:

**W230  
W230X**

Products with this printable area:

**4BC93  
NB93  
WBC93  
CWBC93**

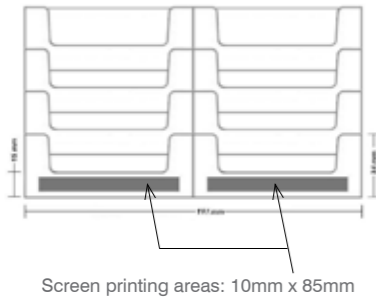

Products with this printable area:  
**8BC93**

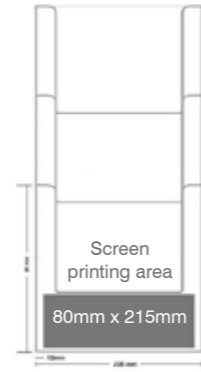

Products with this printable area:  
**3W230**

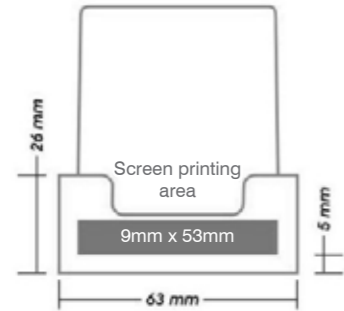

Products with this printable area:  
**VBC56**

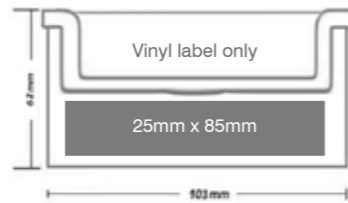

Products with this printable area:  
**OD95**



Products with this printable area:  
**TS110**

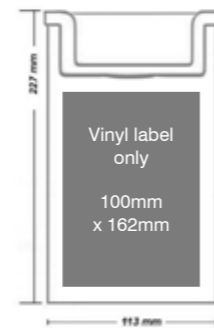

Products with this printable area:  
**OD110**

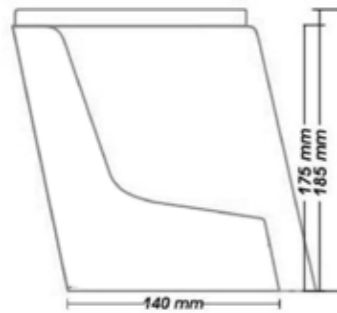

Products with this printable area:  
**TS160**

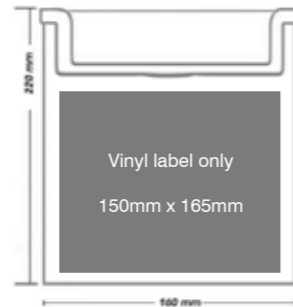

Products with this printable area:  
**OD160**



Products with this printable area:  
**TS230**



Products with this printable area:  
**OD230**

## The last word

Thank you for looking through our brochure. We hope we have been able to supply you with a cost effective and attractive solution for your display requirements and that Taymar products will be able to help you to show your literature effectively but simply.

For further details and product specifications please visit [www.brochureholders.com](http://www.brochureholders.com) or call us to discuss your requirements or answer any questions.

The Taymar team at Brochure Holders International look forward to hearing from you very soon.

Brochure Holders International Ltd  
Unit 1, Holywells Road, Ipswich  
Suffolk, IP3 0DL. United Kingdom

Tel: +44 (0)1473 229250  
Fax: +44 (0)1473 229251

[sales@brochureholders.co.uk](mailto:sales@brochureholders.co.uk)  
[accounts@brochureholders.co.uk](mailto:accounts@brochureholders.co.uk)

[www.brochureholders.com](http://www.brochureholders.com)





Brochure Holders International Ltd  
Unit 1, Holywells Road, Ipswich  
Suffolk, IP3 0DL. United Kingdom

Tel: +44 (0)1473 229250

Fax: +44 (0)1473 229251

[sales@brochureholders.co.uk](mailto:sales@brochureholders.co.uk)

[accounts@brochureholders.co.uk](mailto:accounts@brochureholders.co.uk)

[www.brochureholders.com](http://www.brochureholders.com)

